

Specifications

Output Power HP (kW)	1 (0.75)
Phase	3 Phase
Pole	6 Pole
Frame Number	90L

Degrees of Protection	IP 22
Enclosure Construction	Drip-proof
Thermal Class	Class B (130°C)

Alignment	Vertical
Frame Material	Steel plate

Power Transmission	Direct-couple or Belt Driven
Direction of Rotation	Counterclockwise (CCW) viewed from shaft-end side



Connection Type	Lead Wire (6 Leads)
Coating Colour	Munsell N5.5 (Gray)
Conformed Standard	IEC 60034-1 & JEC-2137-2000



Voltage & Frequency	LT Type	
	220/380~415V	50Hz
	220/440V	60Hz

* () is dimension without drip-proof cover

Dimensions (mm)

Flange Number	Motor							
	D	LA	LB	LC	LE	LG	LL*	LZ
FF165	168	165	130 j6	200	3.5	12	270 (261)	12

Terminal Box			Shaft End						
KB	KD	KL	LR	Q	QK	S	T	U	W
201.5	27	158	50	50	40	24 j6	7	4	8

Bearing No.		Approximated Weight (kg)	Approximated Packing Dimensions (LxWxH)	Gross Weight (kg)
Drive End	Opposite			
6205ZZ	6204ZZ	19	370 x 280 x 235	21

Connection & Connection Diagram

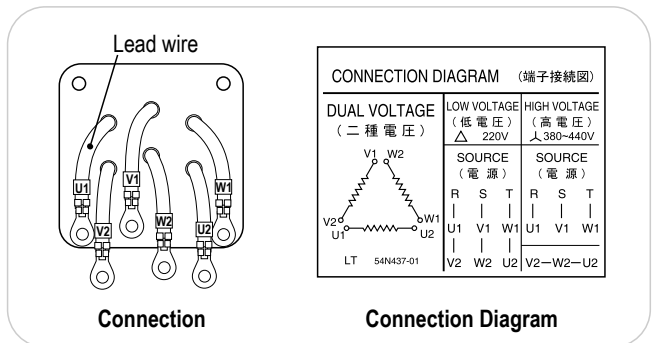

Circumstance Conditions

Ambient Temperature	-20 ~ +40°C
Ambient Humidity	85% RH or less
Operating Altitude	Less than 1,000m above sea level
Environment	No bursting / erosive gas or vapor

Motor Characteristics

Type	Hz	V	50% Load			75% Load			100% Load				Torque(%)		Is (A)	Inertia GD ² (kg-m ²)	
			(A)	Eff(%)	PF(%)	(A)	Eff(%)	PF(%)	(A)	Eff(%)	PF(%)	Speed (r/min)	Torque (kg-m)	Ts			Tm
LT	50	220	2.79	0.71	0.50	3.15	0.76	0.62	3.60	0.78	0.70	940	0.78	278	252	18.5	0.030
		380	1.61	0.71	0.50	1.82	0.76	0.62	2.08	0.78	0.70	940	0.78	278	252	10.7	
		415	1.75	0.68	0.44	1.91	0.74	0.55	2.12	0.77	0.64	950	0.77	335	302	11.6	
60	220	2.44	0.73	0.55	2.85	0.78	0.66	3.38	0.79	0.74	1130	0.65	226	215	15.4		
	440	1.55	0.68	0.47	1.70	0.74	0.59	1.92	0.77	0.67	1150	0.64	306	294	10.3		